

39.Rear Defogger System

A: WIRING DIAGRAM

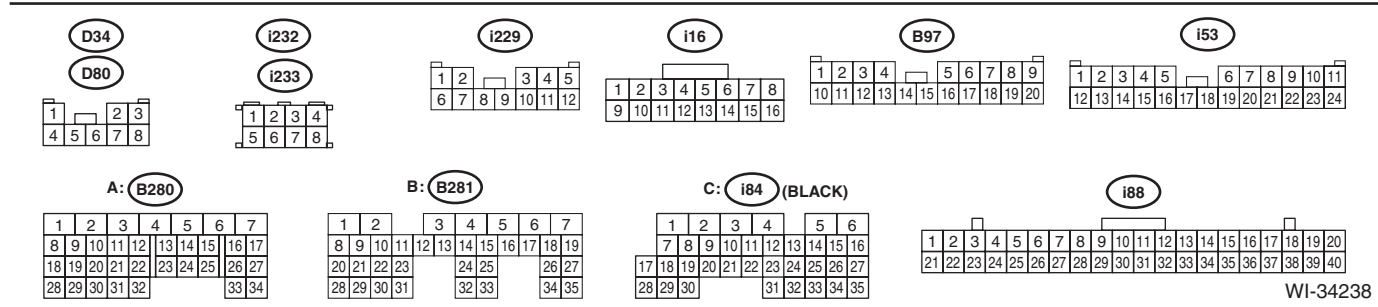
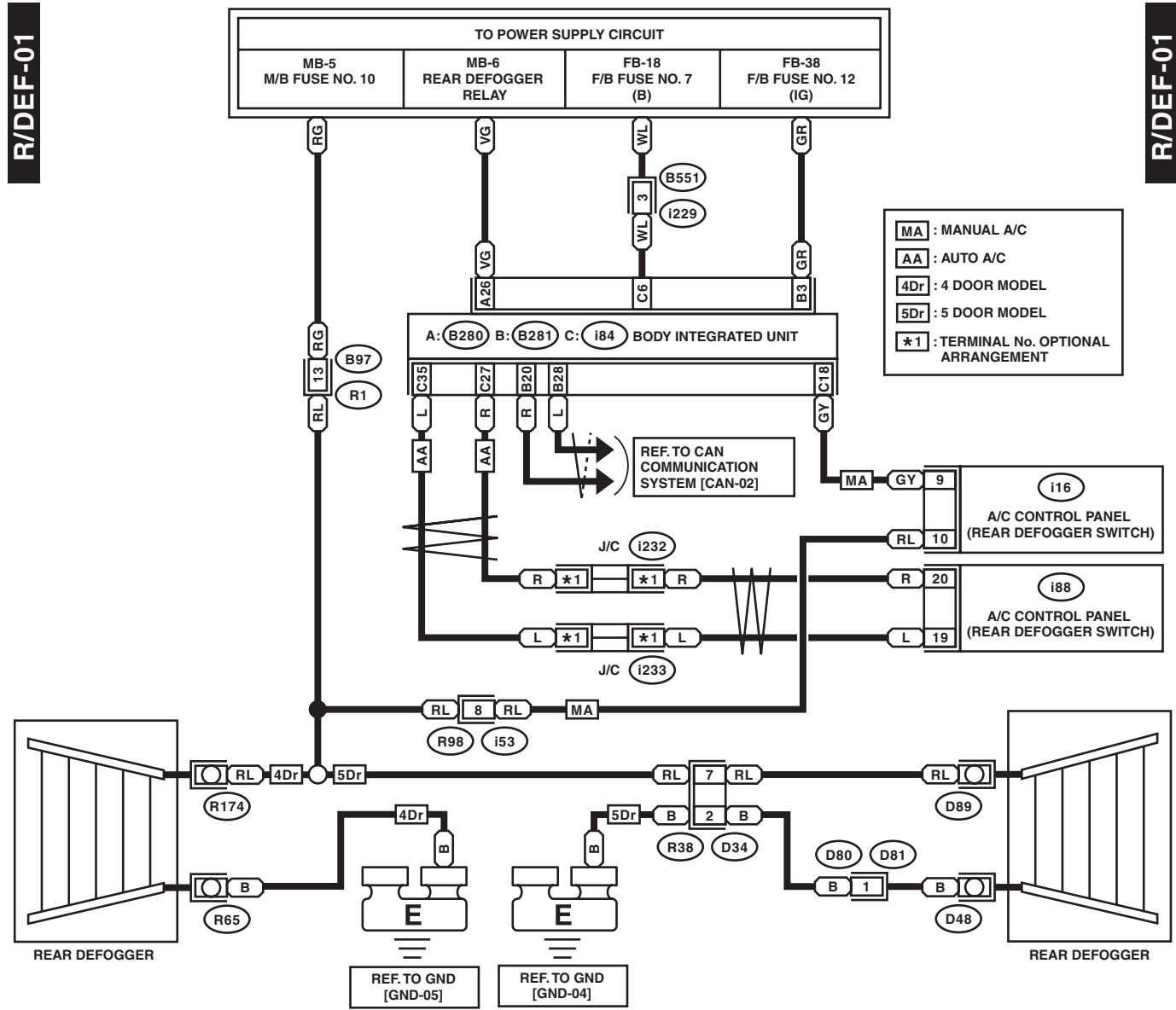

WI-34238